

plan view

1:15 @ A3

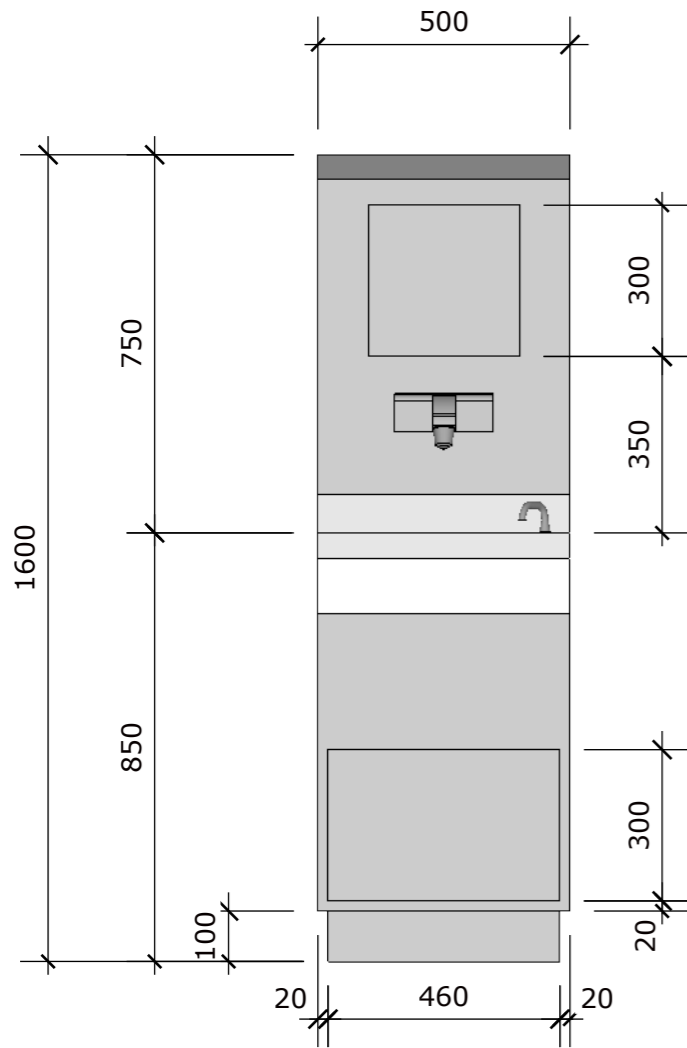
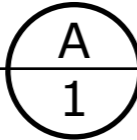

front elevation

1:15 @ A3

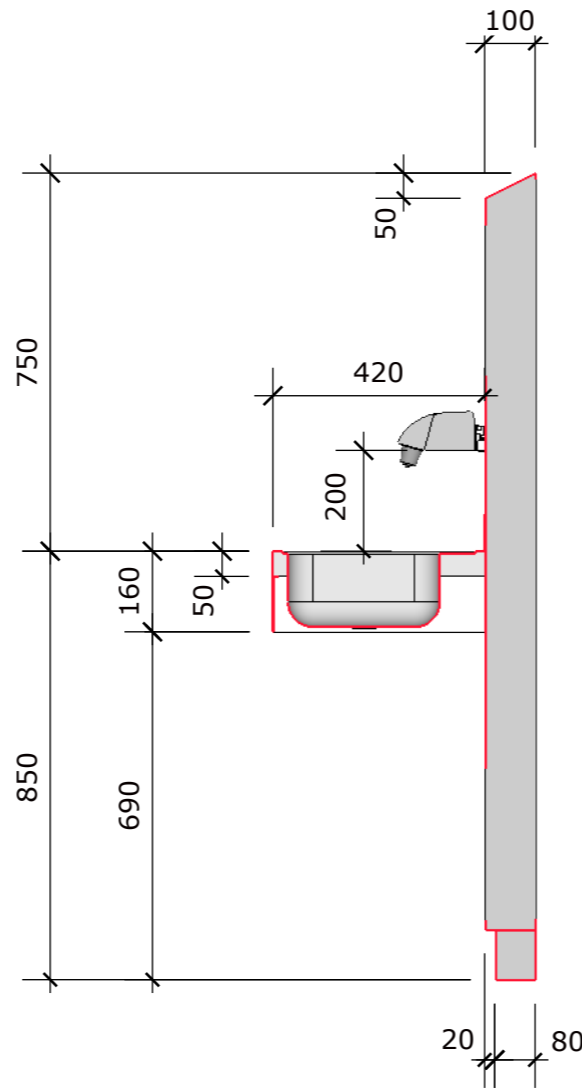
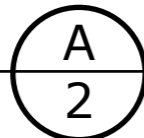

section thru

1:15 @ A3

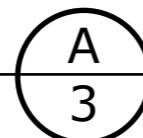

Item 023 Hand Wash Basin

Qty. Required: One (1) x off

Basin units to incorporate a hand wash basin with Yellow Pillar Tap model Y745P, based on Stoddart wash basin model SPPL.WB.H1 with no tap hole pre-punched (Eymac to locate hole as required)

Basin to be mounted off a stainless steel riser duct for services. Duct 100mm deep, splayed to the top as indicated. Provide separate base support and set back 20mm to allow for floor finishes.

Provide the riser duct with two (2) 300 x 300mm removable access panels as indicated. Access panels to be returned on all sides and mounted flush to duct face.

- PC to locate eWater isolators behind upper access panel.
- EC to locate GPO behind upper access panel; position above eWater isolators
- PC to locate tempering valve behind lower access panel

PC to run waste up from floor, within duct base to connect to plug & washer on basin

eWater lines to enter duct from a concealed location.

Plumbing fixtures:

- Provide and fit one (1) x Yellow timertap model Y745P off-set to one side as indicated
- Provide and fit one (1) eWater VDW hand wash dispenser

Waste fitting:

- Provide a 50mm waste outlet

Dispensers:

- Provide one (1) x Bobrick surface mounted towel dispenser, model 2621

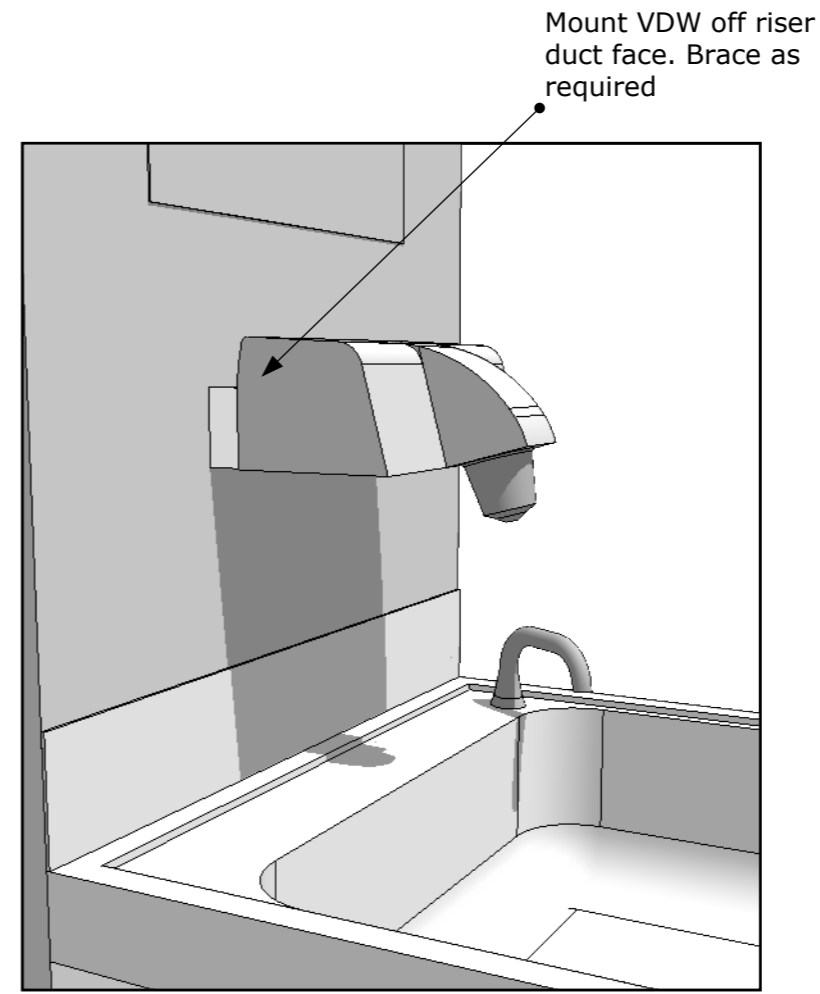
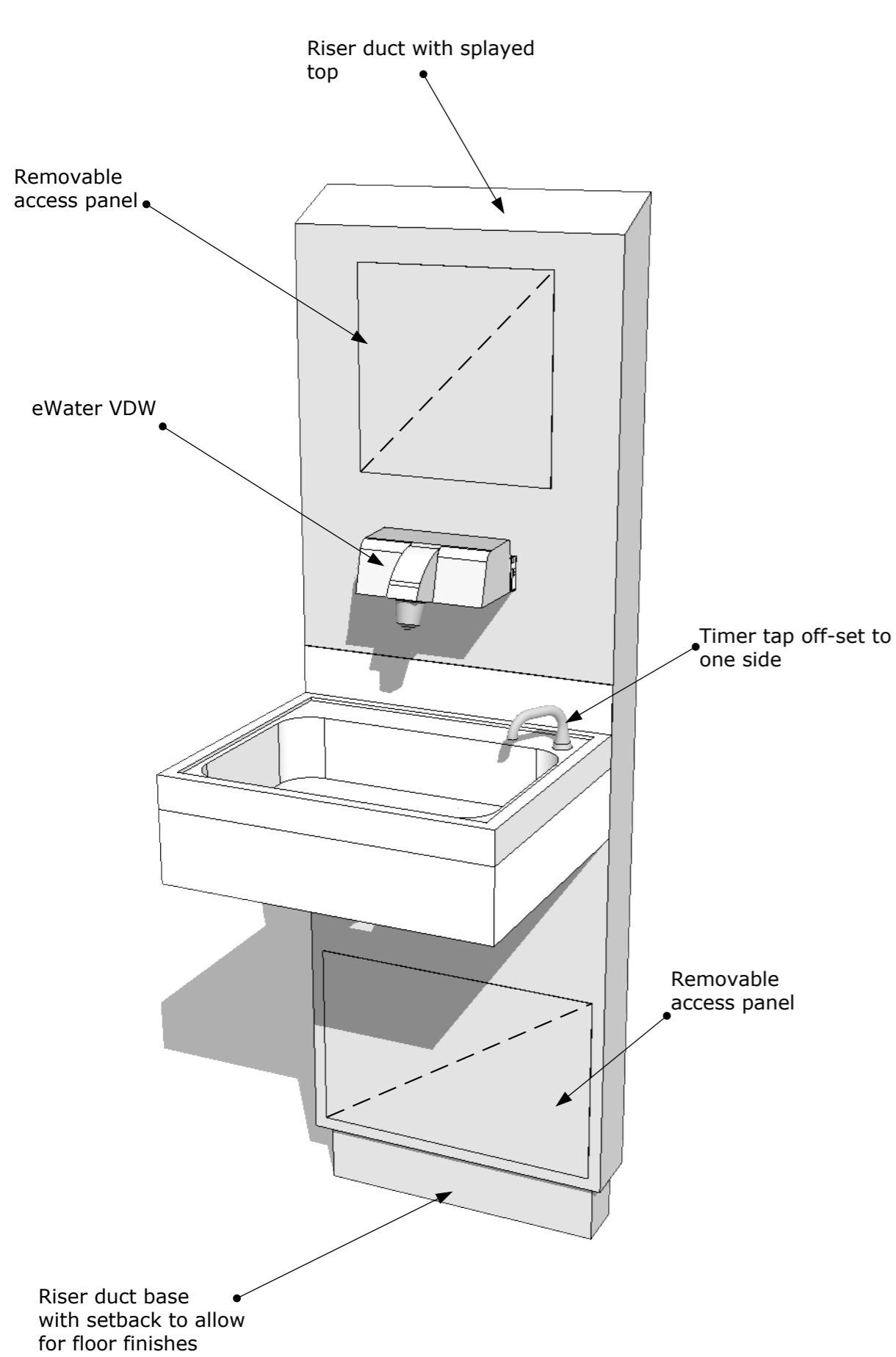

eWater VDW Data Sheet

ITEM	eWater Systems VDW Hand Wash Dispensing Unit
MODEL	VDW-2PB-E (EW)
POWER SUPPLY	1 Phase 90-264V 47-63Khz 0.05kVA(Unit: 12V DC)
AMPERAGE	0.4/D.4A
ELECTRIC CONSUMPTION	25W/25W
POWER CORD	-
OUTSIDE DIMENSIONS	196mm (W) x 174mm (D) x 112mm (H) Depth: Adjustable 174 - 204mm in 10mm steps
EXTERIOR	ABS Plastic
CONNECTIONS	Quick Fitting 8mm Diameter (Cleaning water x 1, Sanitising water x 1)
INSTALLATION CONDITIONS	Indoor
SAFETY DEVICE PROTECTION	-
WEIGHT	2kg (Gross 2.5kg)
ACCESSORIES	8x6mm Diameter Hose for quick fitting, Hose Clamp, Truss Head Machine Screw, Quick Fitting 8mm diameter, PVC Fitting(8mm DIA/13A), Valve Socket(13A)
OPERATING CONDITIONS	Ambient Temp: 5-30c, Water Temp: 5-30c, Water Supply Pressure: Max 0.2MPa(2.0bar)
PACKAGE	Carton 300mm(W) x 220mm (D) x 139mm (H)

